



US00D788367S

(12) **United States Design Patent** (10) **Patent No.:** **US D788,367 S**
Nordstrom (45) **Date of Patent:** **** May 30, 2017**

(54) **SAFETY RAZOR BASE PLATE**

OTHER PUBLICATIONS

(71) Applicant: **ROCKWELL RAZORS CORPORATION**, Toronto (CA)

International Searching Authority, International Search Report and Written Opinion issued Nov. 27, 2015 in International Patent Application No. PCT/CA2015/000491.

(72) Inventor: **Morgan Nordstrom**, Ottawa (CA)

(Continued)

(73) Assignee: **ROCKWELL RAZORS CORPORATION**, Toronto, Ontario (CA)

Primary Examiner — Jennifer Rivard

(74) *Attorney, Agent, or Firm* — Norton Rose Fulbright Canada LLP

(**) Term: **15 Years**

(21) Appl. No.: **29/539,215**

(57) **CLAIM**

(22) Filed: **Sep. 11, 2015**

The ornamental design for a safety razor base plate, as shown and described.

(51) **LOC (10) Cl.** **28-03**

(52) **U.S. Cl.**

USPC **D28/47**

(58) **Field of Classification Search**

USPC D28/46–48

CPC B26B 21/52–21/528; B26B 21/14–21/38;

B26B 21/40; B26B 21/4006; B26B

21/4012–21/4031; B26B 21/4068; B26B

21/4072

See application file for complete search history.

DESCRIPTION

FIG. 1 is a perspective view of the safety razor base plate with additional environment shown in broken lines;

FIG. 2 is a bottom perspective view of the safety razor base plate in FIG. 1;

FIG. 3 is a top view of the safety razor base plate in FIG. 1;

FIG. 4 is a front view of the safety razor base plate in FIG. 1;

FIG. 5 is a bottom view of the safety razor base plate in FIG. 1;

FIG. 6 is a rear view of the safety razor base plate in FIG. 1;

FIG. 7 is a left side view of the safety razor base plate in FIG. 1; and,

FIG. 8 is a right side view of the safety razor base plate in FIG. 1.

The design is the visual features of the safety razor base plate shown in solid lines in the drawings. The broken line disclosure of the word ROCKWELL is a registered trademark of Rockwell Razors. The broken line disclosure of the razor in FIG. 1 illustrates the environment. None of the broken lines forms part of the claimed design.

(56) **References Cited**

U.S. PATENT DOCUMENTS

1,071,970	A	9/1913	Stutzman
1,496,295	A	6/1924	Chance
1,765,805	A	6/1930	Schlussler
1,815,745	A	7/1931	Thompson
1,923,439	A	8/1933	Hukill
2,128,772	A	8/1938	Green
2,141,339	A	12/1938	Bauerle

(Continued)

FOREIGN PATENT DOCUMENTS

CA	799671	A	11/1968
CN	2710852	Y	7/2005

(Continued)

1 Claim, 8 Drawing Sheets

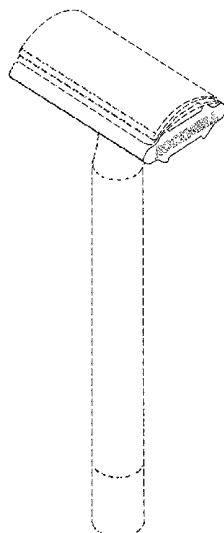

(56)

References Cited

U.S. PATENT DOCUMENTS

2,270,388 A 1/1942 Stampleman
 2,321,350 A 6/1943 Ardner
 2,333,894 A 11/1943 Smith
 2,342,161 A 2/1944 Muros et al.
 2,472,807 A 6/1949 Clark
 2,567,811 A 9/1951 Haushalter
 2,573,980 A * 11/1951 Mitchell B26B 21/16
 30/83
 2,637,101 A * 5/1953 Cutler B26B 21/24
 30/40.2
 2,637,905 A 5/1953 Williams et al.
 2,669,777 A 2/1954 Scully
 2,671,265 A * 3/1954 Gavrilla B26B 21/06
 30/32
 2,705,834 A 4/1955 Lundy
 D175,896 S * 10/1955 MacMicking D28/47
 2,794,246 A * 6/1957 Marsh B26B 21/06
 30/32
 3,015,158 A * 1/1962 Ayotte B26B 21/16
 30/41
 3,079,685 A 3/1963 Scully
 3,088,206 A 5/1963 Muros
 3,129,508 A 4/1964 Dootson
 3,413,720 A * 12/1968 Mullen B26B 21/06
 30/32
 3,583,262 A * 6/1971 Mullen B26B 21/06
 29/525
 3,626,591 A * 12/1971 Robey B26B 21/40
 30/54
 3,680,211 A 8/1972 Keck
 3,748,735 A 7/1973 Whittington
 3,777,396 A * 12/1973 Simonetti B26B 21/22
 30/346.57
 3,889,370 A 6/1975 Hale, III
 4,066,111 A 1/1978 Klebe, Jr.

4,749,014 A 6/1988 Schlund
 5,363,892 A 11/1994 Hild et al.
 7,100,649 B2 9/2006 Liu
 D763,506 S * 8/2016 Barrett D28/46
 2009/0007443 A1 * 1/2009 Cuocolo, Jr. B26B 21/10
 30/526
 2011/0197446 A1 * 8/2011 Macove B26B 21/22
 30/34.2
 2015/0298327 A1 * 10/2015 Tomassetti B26B 21/48
 30/34.05
 2015/0352737 A1 * 12/2015 Hickam B26B 21/521
 30/70
 2016/0075040 A1 * 3/2016 Nordstrom B26B 21/18
 30/71

FOREIGN PATENT DOCUMENTS

DE 2544425 A1 4/1976
 DE 202013005918 U1 9/2013
 FR 737509 A 12/1932
 GB 193704 A 3/1923
 GB 504986 5/1939
 GB 714122 8/1954

OTHER PUBLICATIONS

shaveinfo.com, "About Razor Blade Angles FAQ's", <http://shaveinfo.com/shaving-information/blade-angle.htm>, May 2015.
 Maggard Razors Maggard Razors MR1 Knurled Stainless Steel Handle Safety Razor, <http://www.maggardrazors.com/product-maggard-razors-mr1-chrome-safety-razor/>, last accessed Jan. 5, 2016.
 Muehle Shaving Culture, Product Section—Safety Razors, <http://www.muehle-shaving.com/en/Product-world/Razors/>, last accessed Jan. 5, 2016.
 United States Patent and Trademark Office, Office Action issued in U.S. Appl. No. 14/484,330 dated May 27, 2016.

* cited by examiner

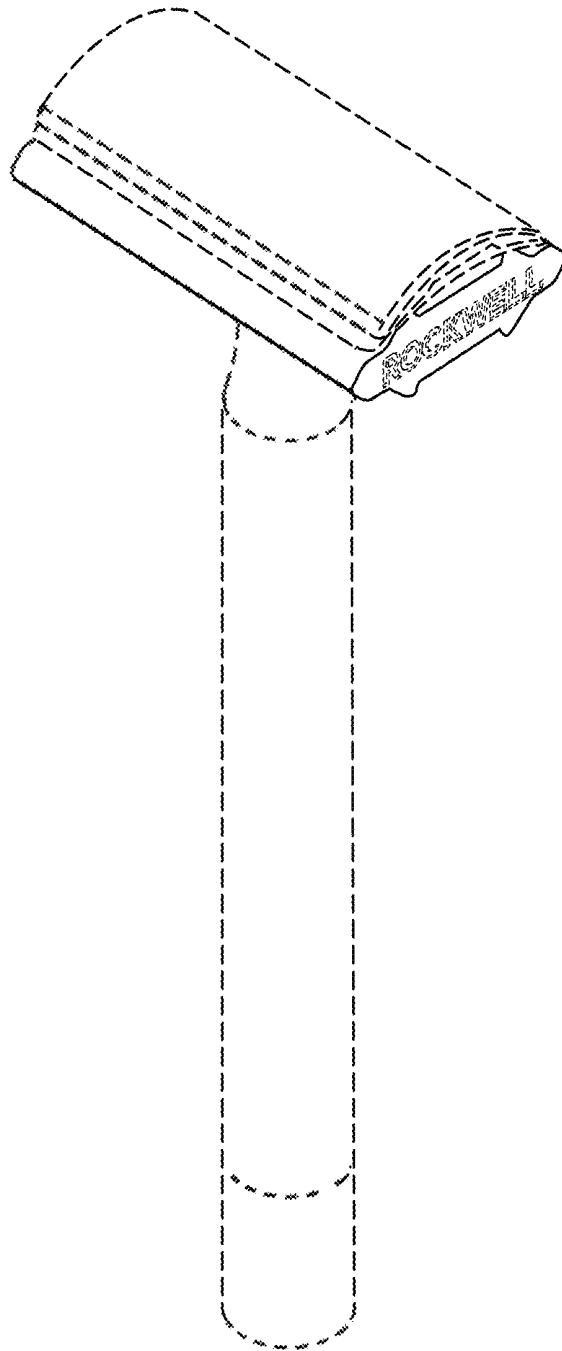

FIG. 1

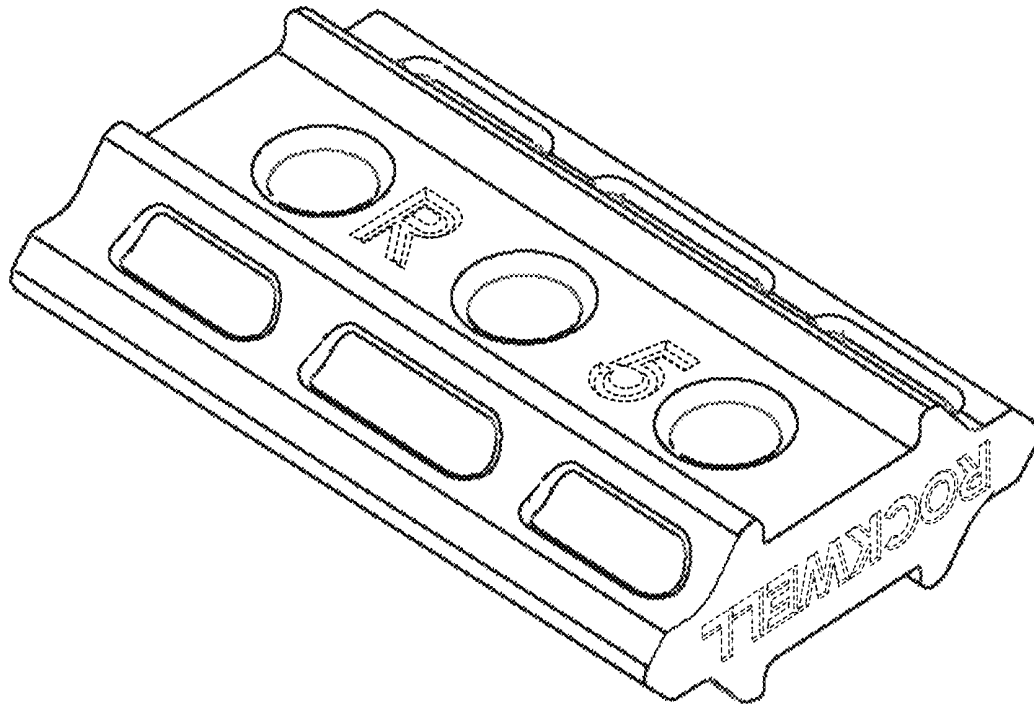

FIG. 2

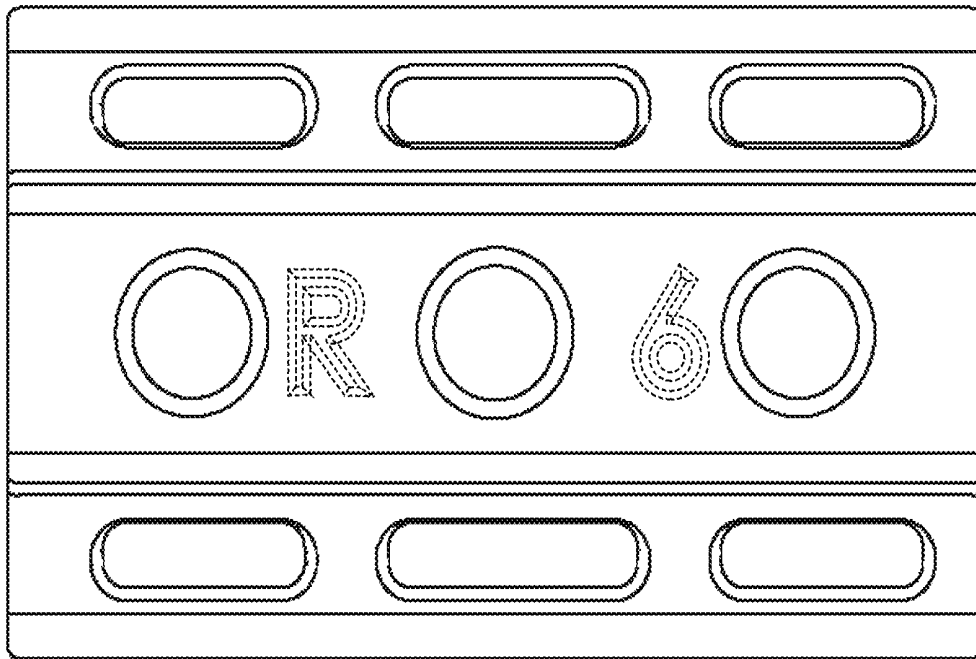

FIG. 3

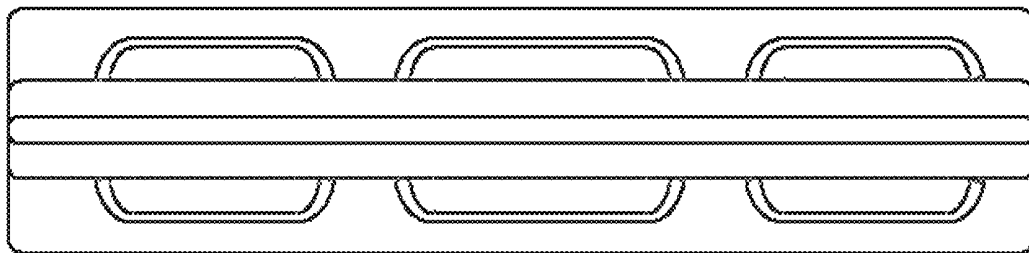

FIG. 4

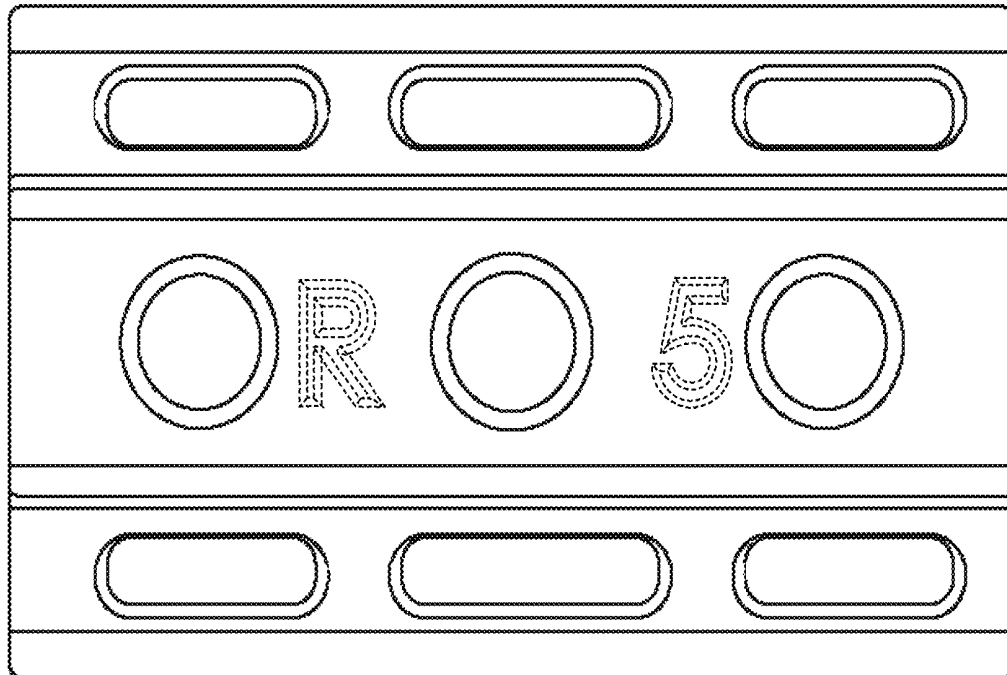

FIG. 5

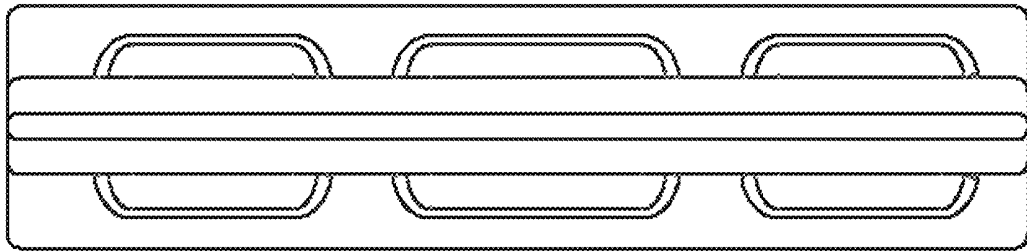

FIG. 6

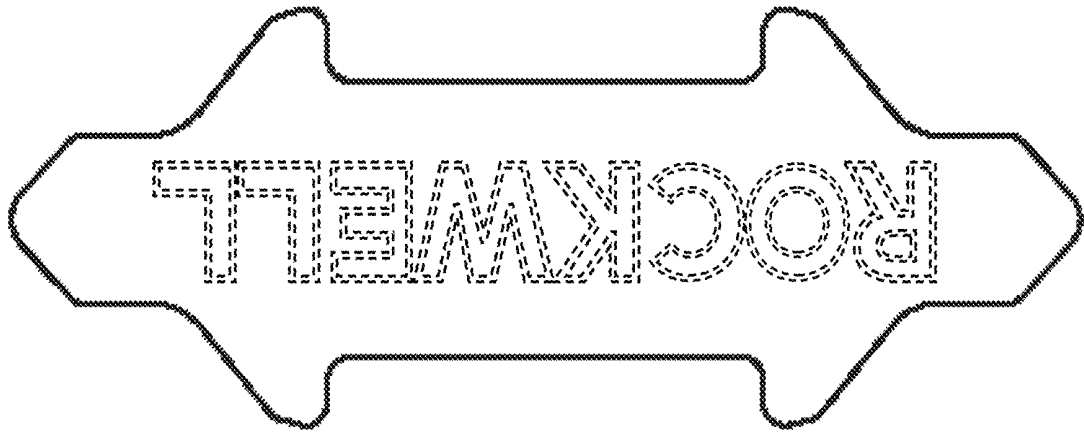

FIG. 7

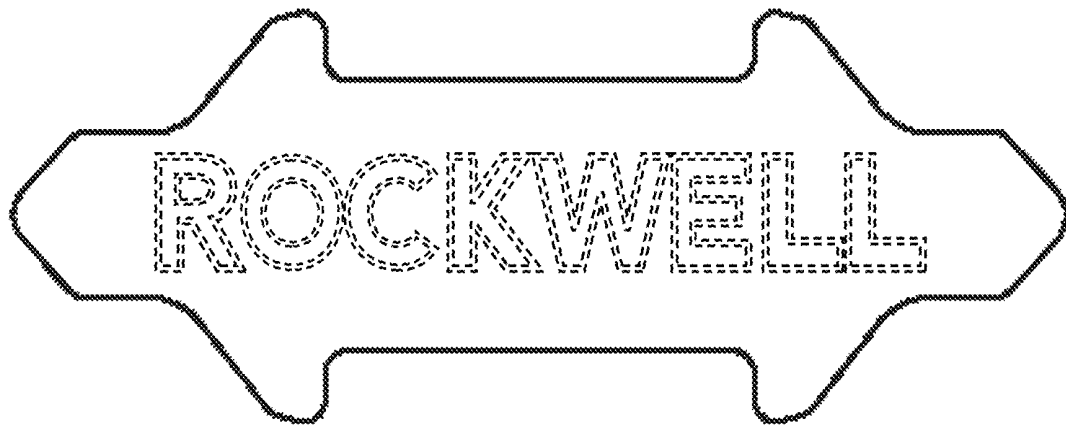

FIG. 8